

SOI Asia Classroom Environment

SOI Asia Operator Workshop
2004 summer

August 14, 2004

Shoko Mikawa funya@sfc.wide.ad.jp

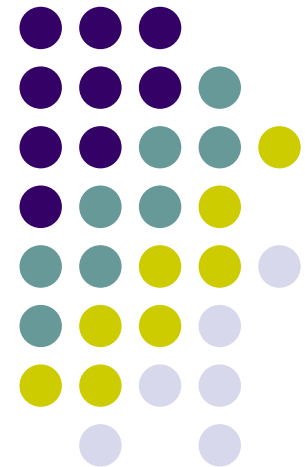



Lecture overview

- SOI Asia network overview
- SOI Asia lecture overview
- Hardware and Software preparation
- SOI Asia Realtime lecture

SOI Asia Network flow

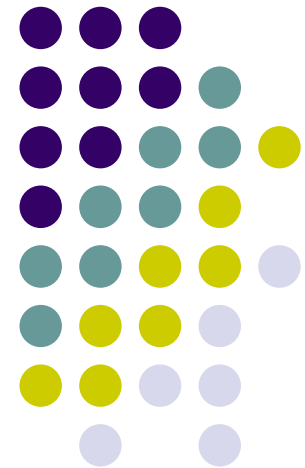

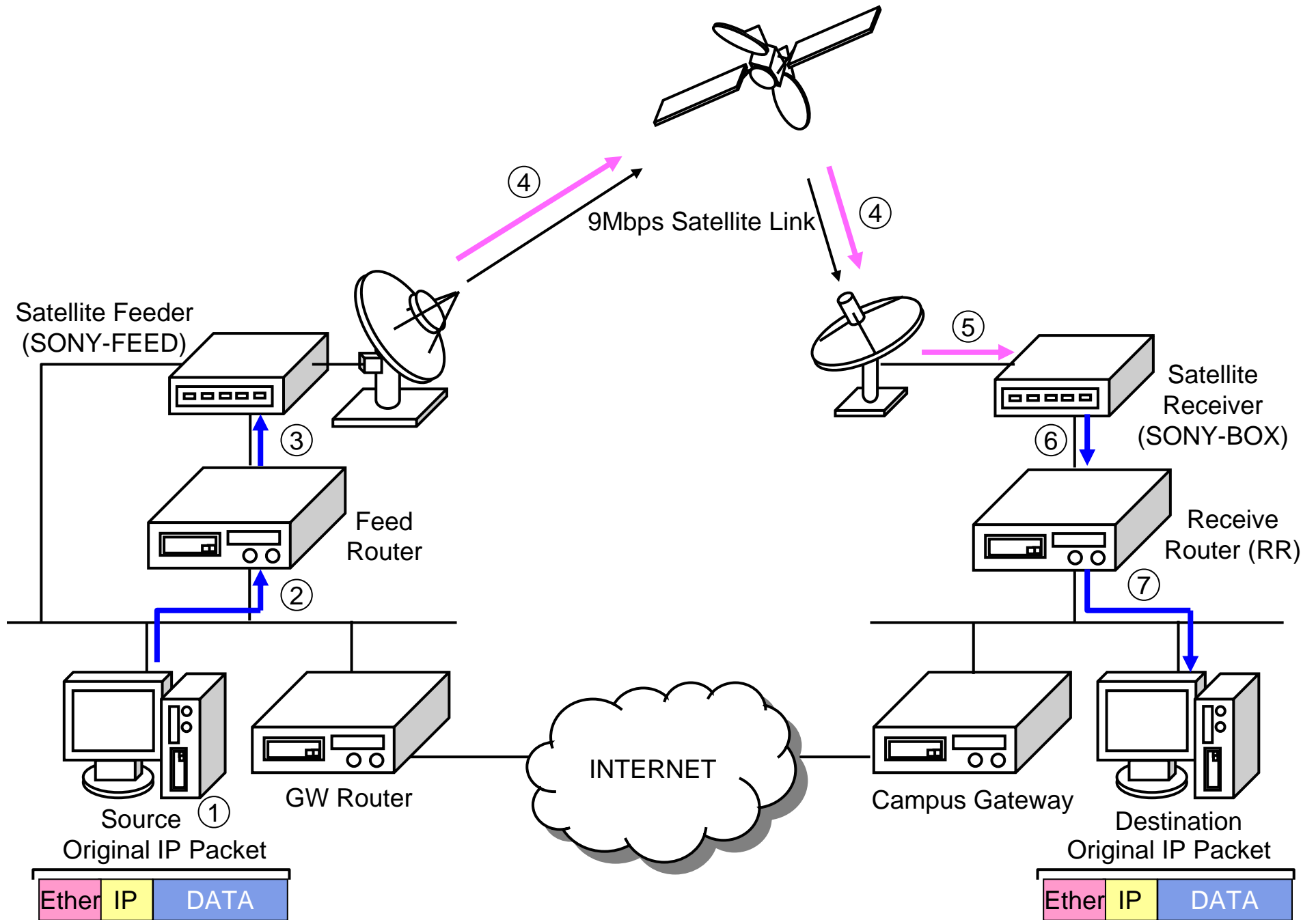

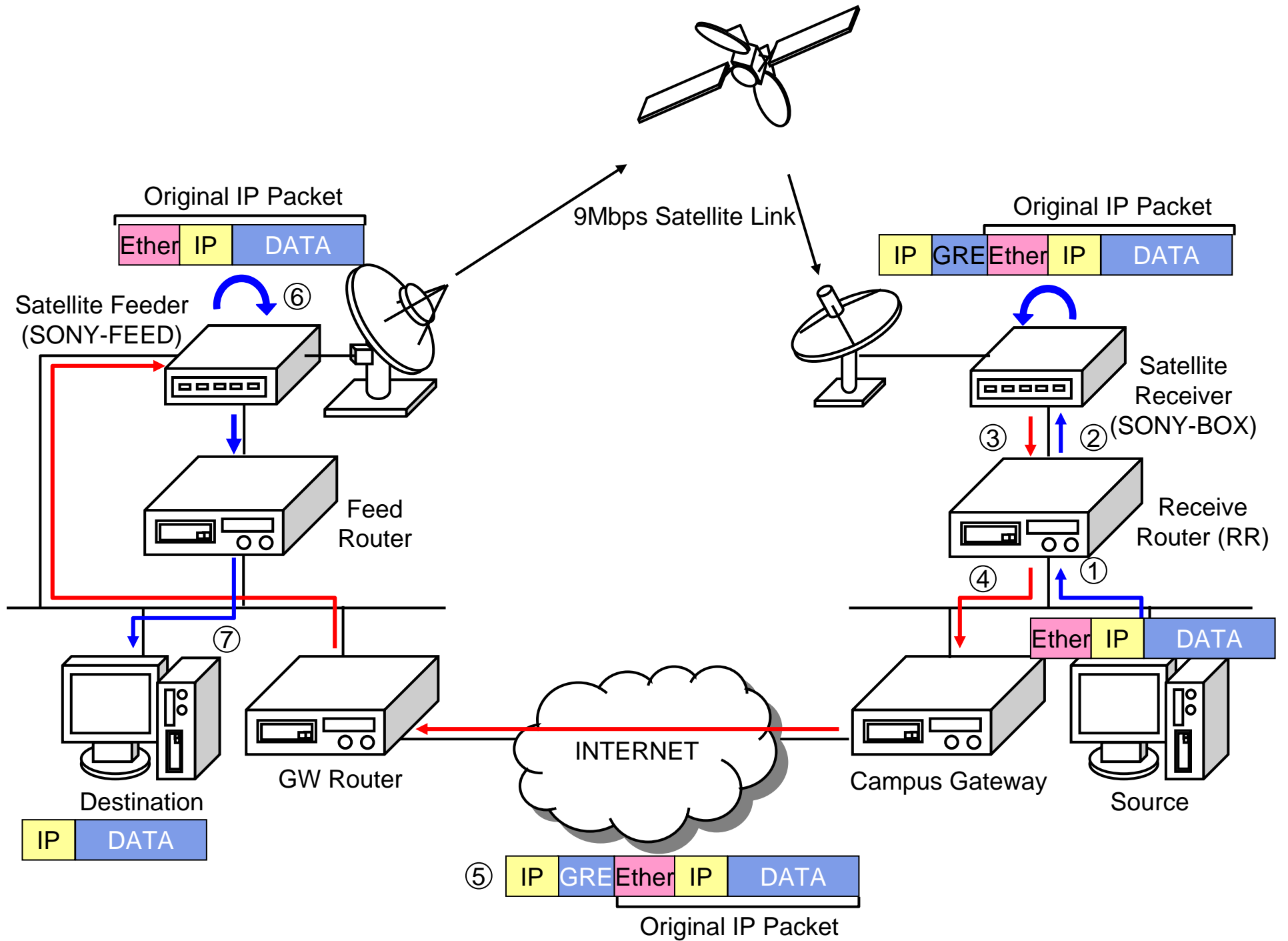

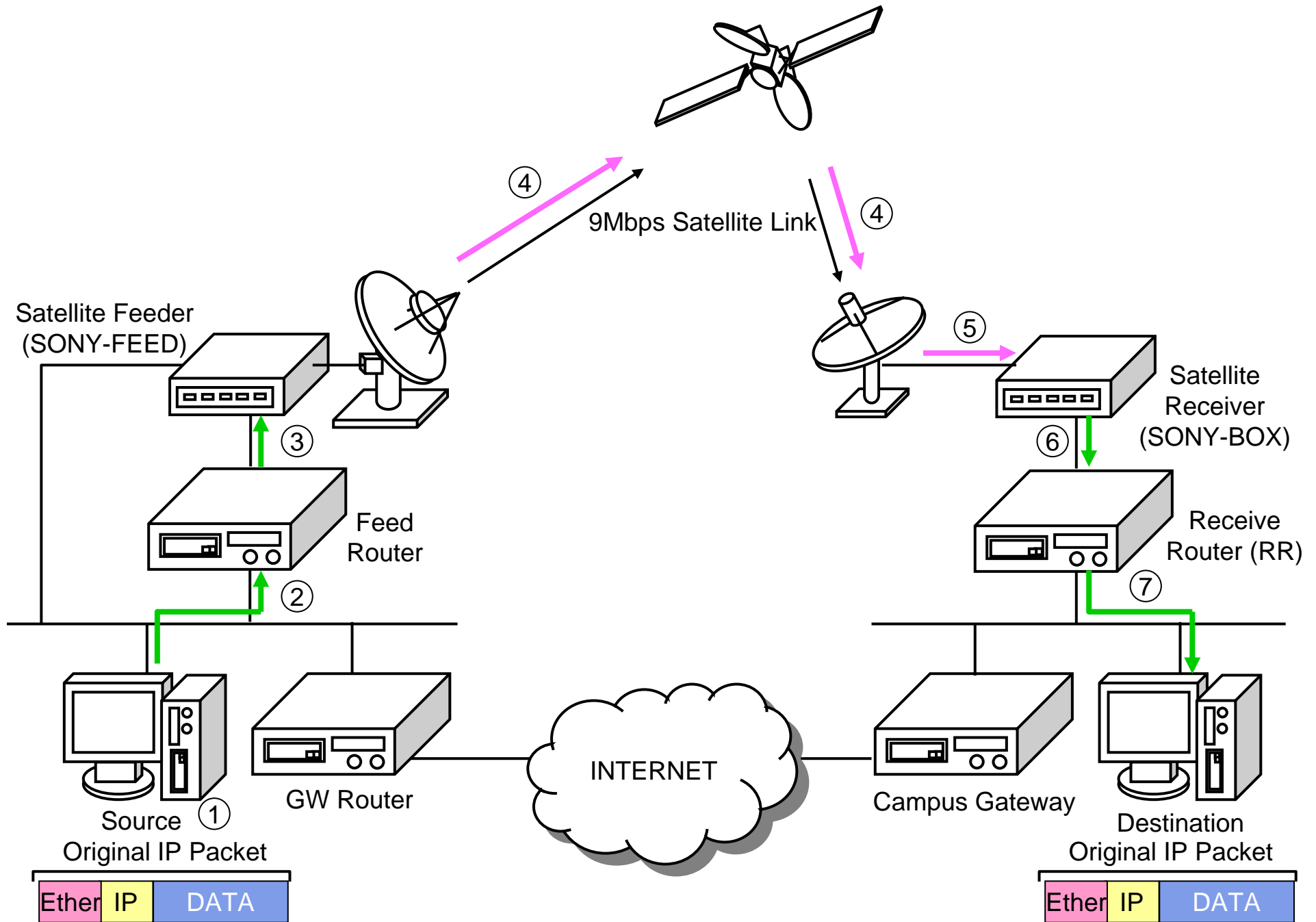

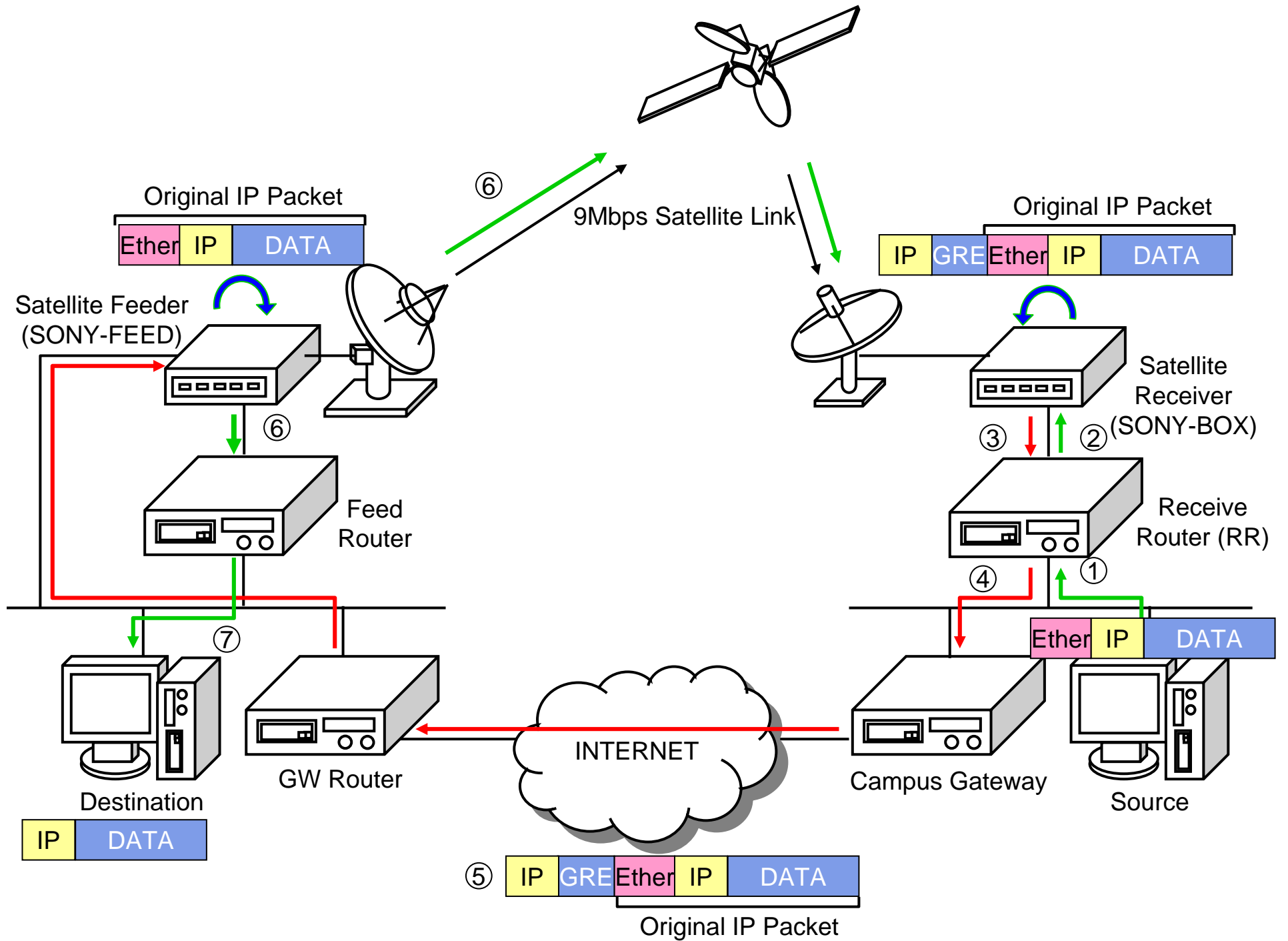

SOI Asia Lecture overview

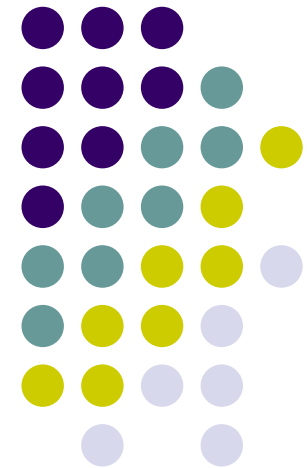

SOI Asia network overview

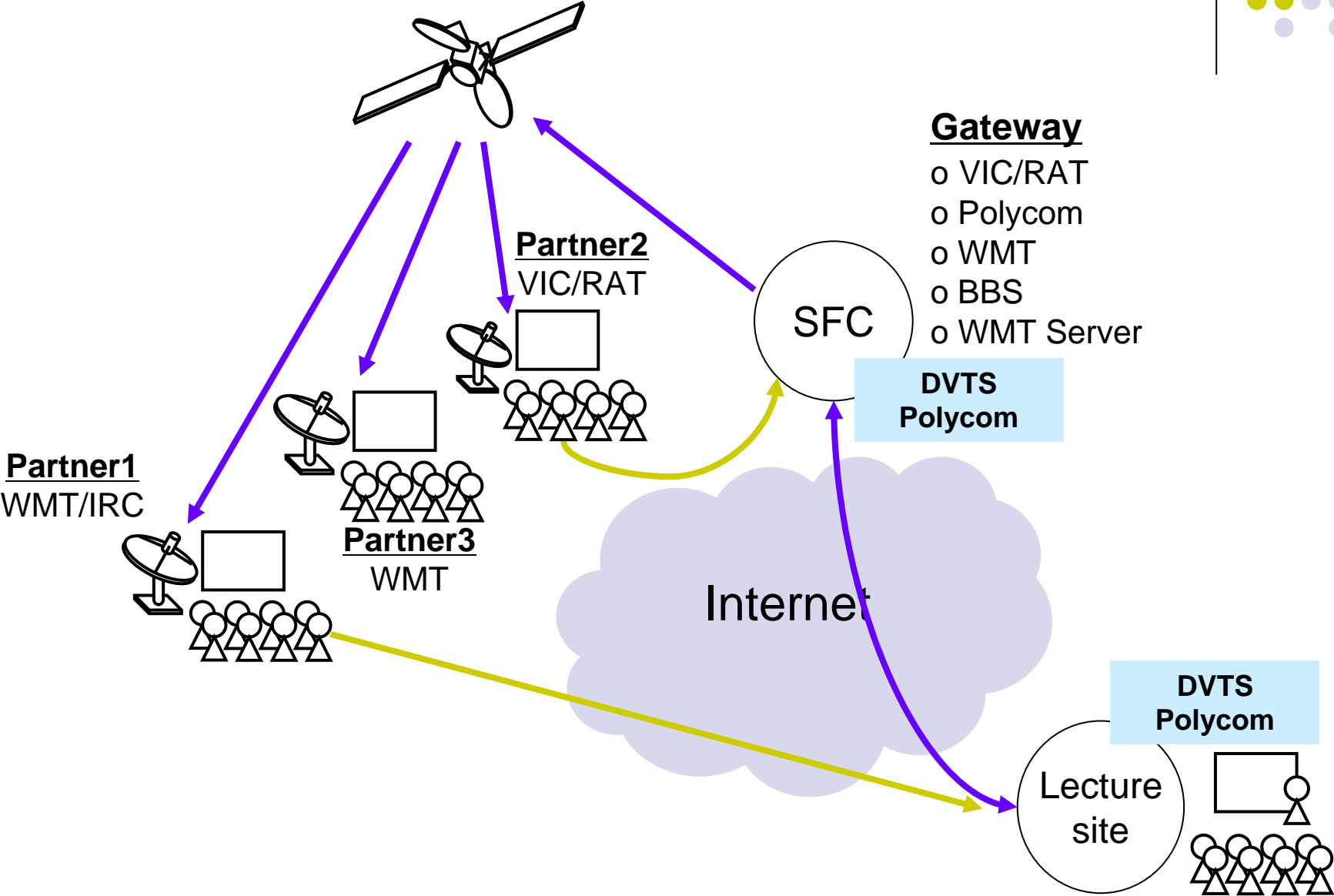

Classroom application



	Lecture	Break	Q & A session
More than 2Mbps connectivity	<ul style="list-style-type: none">• VIC/RAT• RPT• IRC	Change the configuration	<ul style="list-style-type: none">• VIC/RAT• RPT• IRC• BBS
More than 128kbps connectivity	<ul style="list-style-type: none">• Windows Media Player• RPT• IRC		<ul style="list-style-type: none">• VIC/RAT• RPT• IRC• BBS
Less than 128kbps connectivity	<ul style="list-style-type: none">• Windows Media Player• RPT• IRC		<ul style="list-style-type: none">• Windows Media Player• RPT• IRC• BBS

Hardware and Software Configuration

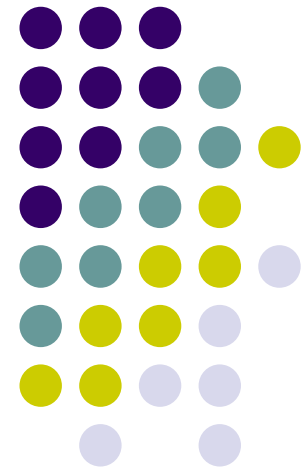

Simplest configuration for QA

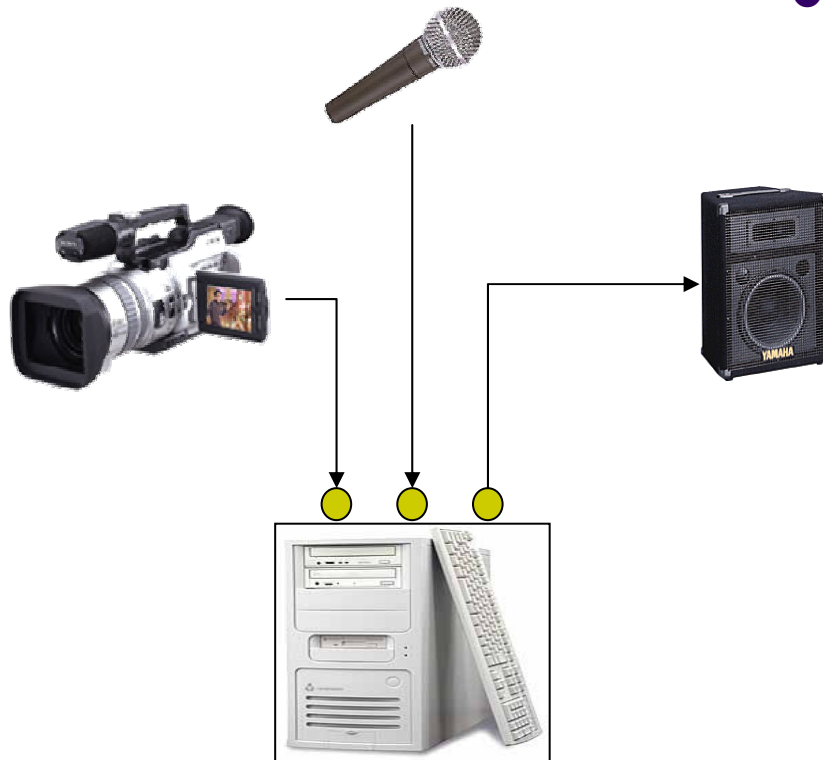

- Problems
 - Echo is coming back
 - Audio level is different in each site

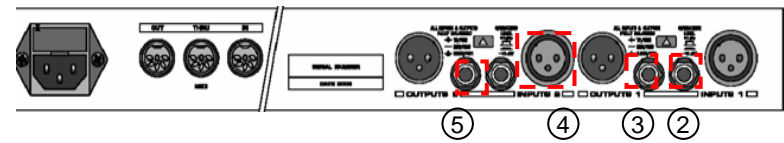
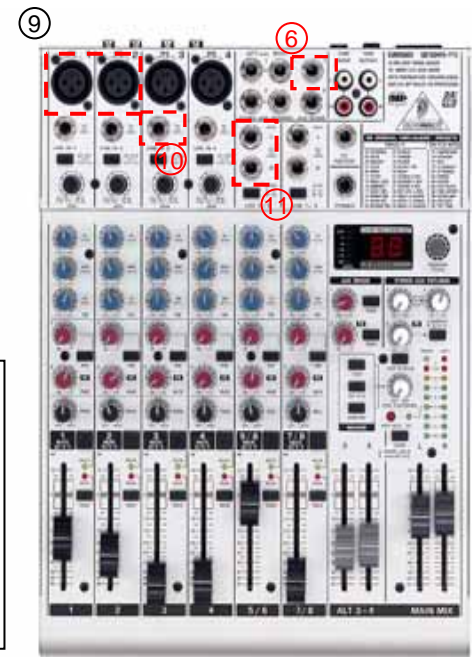
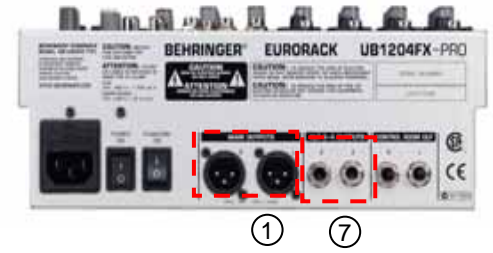
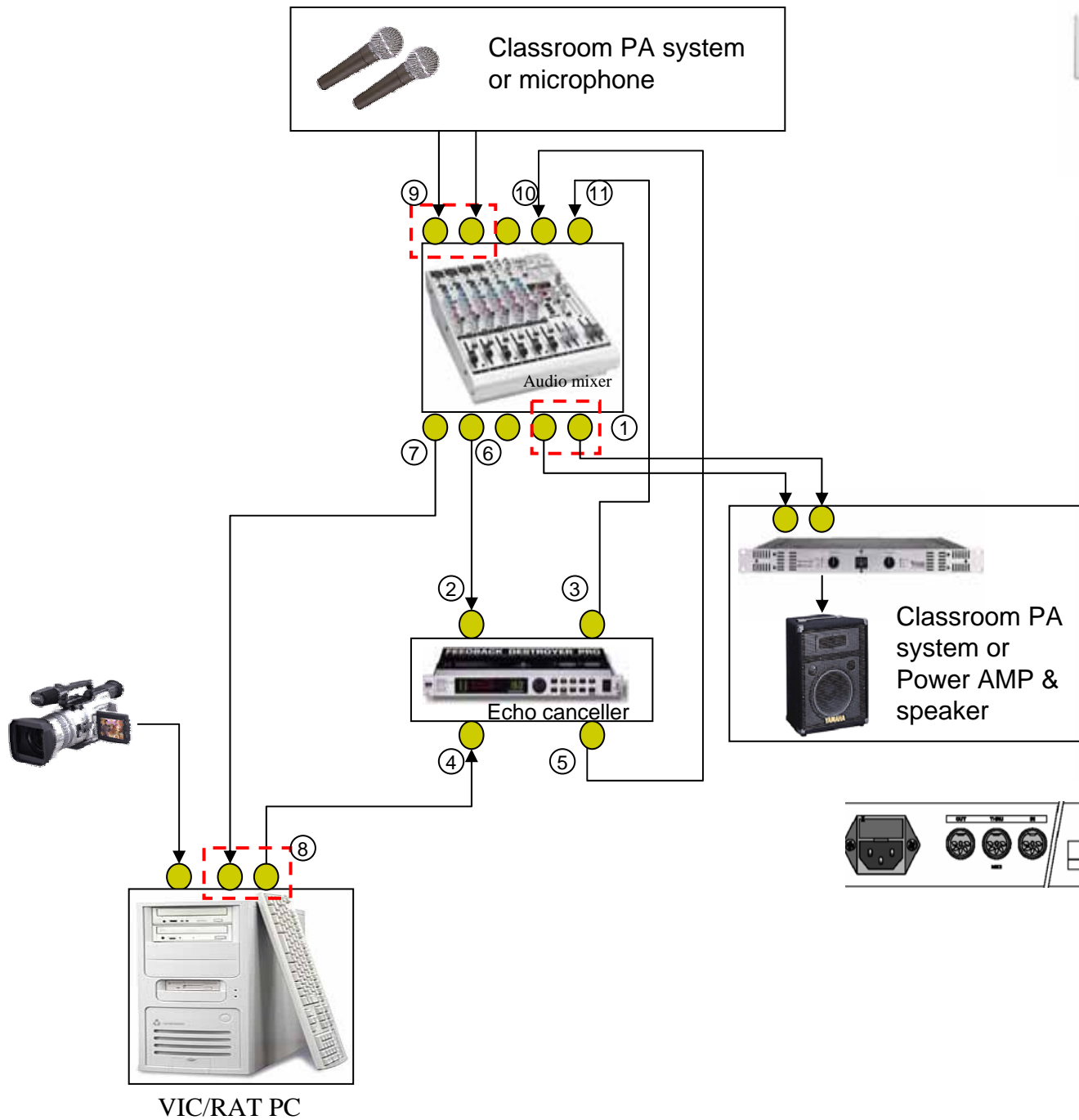

Audio Mixer

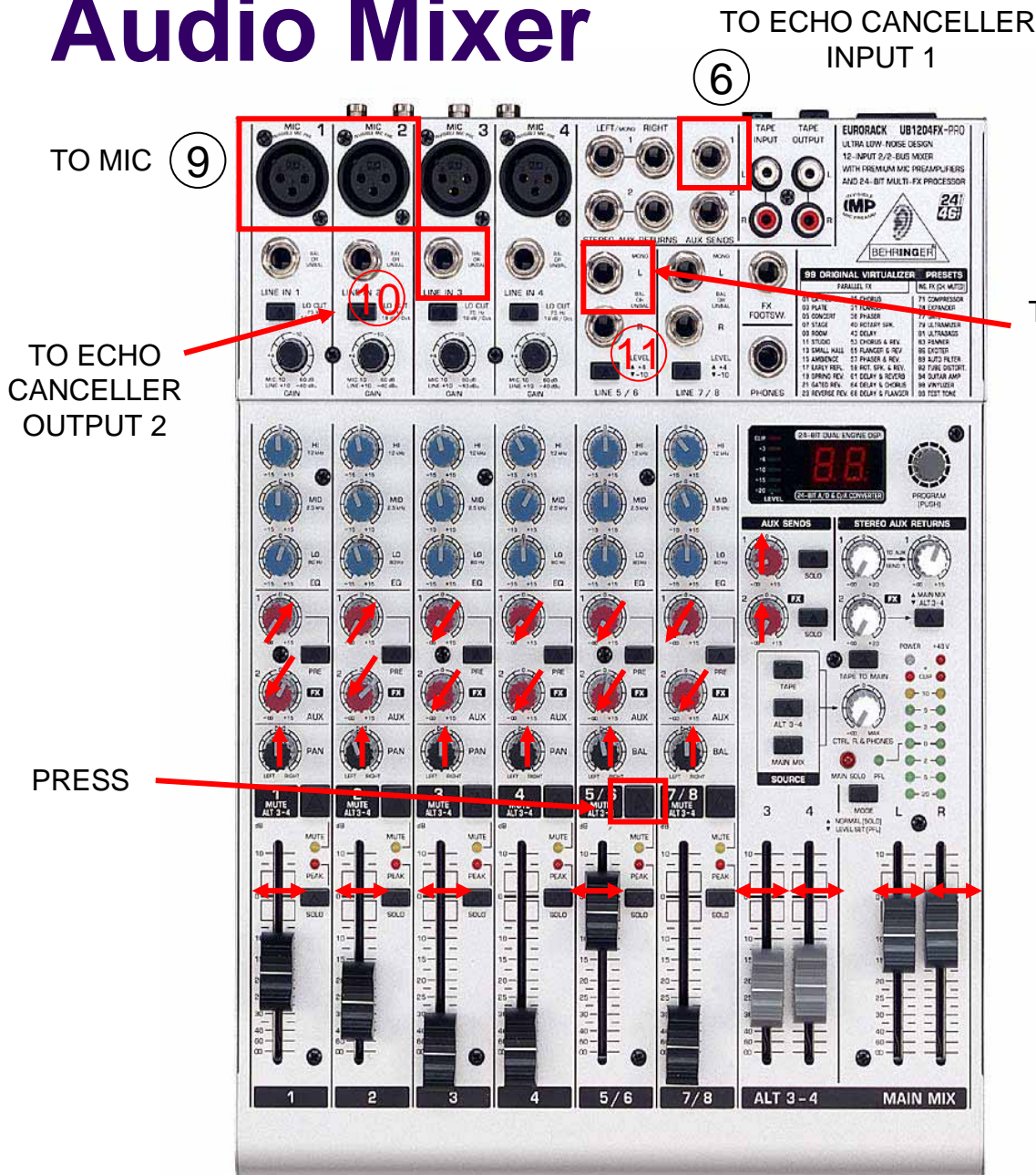

1 7

TO CLASSROOM PA or POWER AMP

TO VIC/RAT LINE IN

Echo canceller

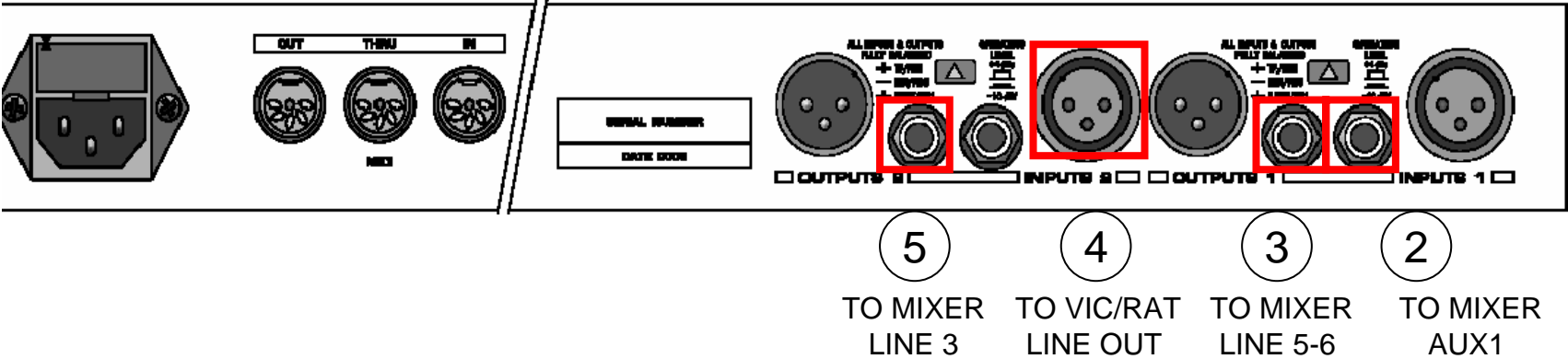



Echo canceller

- Check before you plug in to power
 - 100bolt / 240bolt
- Configuration
 - Set the channel to 1
 - Automatically cancels the echo
 - Mono audio canceller



Cables



RGB cable



CANON cable



Stereo mini cable



MIC / CANON cable



VIC/RAT

- For Q/A session
- Sending about 1.5Mbps video and audio from Japan
- Advantage
 - There is no encoding/decoding delay
- Disadvantage
 - Return path to the gateway site is required
- Usage
 - Download the applications and install
 - <http://www.soi.wide.ad.jp/projec/soi-asia/manual/vic-rat/>
 - Start the application from command line
 - "C:¥Program Files¥mbone¥vic.exe" 233.18.109.3/6666
 - "C:¥Program Files¥mbone¥rat.exe" 233.18.109.4/7777
 - Start sending with minimum bandwidth, and follow JP staff instruction for increasing the quality



Windows Media Player

- For receiving the lecture from Japan
- Sending 500kbps(video+audio) stream from Japan
- Advantage:
 - Return path to Gateway site is not required
 - Better video/audio than VIC/RAT
 - Full screen
- Disadvantage:
 - Encoding/Decoding delay for 30sec to 1min.
- Usage:
 - Download
 - <http://www.microsoft.com/windows/windowsmedia/download/>
 - Get .asx and .nsc files
 - <http://www.soi.wide.ad.jp/soi-asia/wmt/>
 - Click .asx file for start playing

RPT



- For synchronized presentation
- Advantage:
 - Staff does not need to change the slides (works automatically)
- Disadvantage:
 - Sometimes the materials does not match with the video/audio because of encoding/decoding delay
- Usage:
 - Download and install the RPT to a PC
 - <http://www.soi.wide.ad.jp/soibbeans/index-e.html>
 - Put RPTHook.dll to the following directory
 - Windows95,98,2000 > C:\WINDOWS\system32
 - WinXP > C:\WINDOWS\system32
 - Get PowerPoint file from the staff page
 - <http://www.soi.wide.ad.jp/soi-asia/staff/>
 - Open PowerPoint file and start RPT
 - Join IRC
 - VIC/RAT > #soi-rpt
 - Windows Media Player > #soi-rpt2
 - You can also check by joining above channels at the staff PC
 - RPT START
 - RPT SLIDE 19
 - RPT SLIDE NEXT



Staff Communication (1)

- IRC
 - Deciding the order of Q/A through the IRC
 - Reporting lecture status at each site
 - Advantage:
 - Can send messages to everyone
 - We can follow the logs
 - Disadvantages:
 - Sometimes hard to connect to JP server
 - Usage
 - Download the application and install
 - mIRC: <http://www.mirc.com/>
 - CHOCOA: <http://www.labs.fujitsu.com/en/freesoft/chocoa/>
 - Join the channel #soi-asia
 - Set keywords at the menu
 - Example: funya, shoko, sfc to respond quickly at IRC



Staff communication (2)

- MSN Messenger / Yahoo Messenger
 - Staff communication
 - Advantage:
 - Stable connection to the nearest MSN server
 - Can recognize the message soon
 - Disadvantage
 - Cannot send messages to everyone
 - Usage
 - Download the application and install
 - <http://messenger.msn.com/>
 - <http://messenger.yahoo.com/>
 - Add contacts for other partner site staff

Collecting MSN ID and Yahoo ID



- For daily communication, please let us know your MSN ID and Yahoo ID
 - Hand out a paper and pen 😊